

COMMANDER 200
Universal
Process Controller

Operating Guide

MODBUS (RTU)
Communications Option



ABB Instrumentation



ABB INSTRUMENTATION

The Company

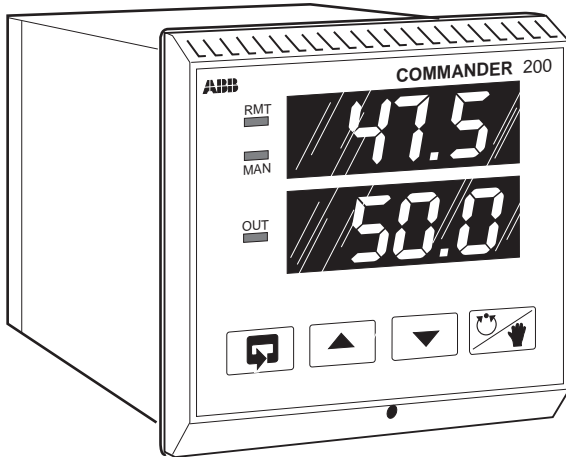
ABB Instrumentation is an established world force in the design and manufacture of instrumentation for industrial process control, flow measurement, gas and liquid analysis and environmental applications.

As a part of ABB, a world leader in process automation technology, we offer customers application expertise, service and support worldwide.

We are committed to teamwork, high quality manufacturing, advanced technology and unrivalled service and support.

The quality, accuracy and performance of the Company's products result from over 100 years experience, combined with a continuous program of innovative design and development to incorporate the latest technology.

The NAMAS Calibration Laboratory No. 0255(B) is just one of the ten flow calibration plants operated by the Company, and is indicative of ABB Instrumentation's dedication to quality and accuracy.

BS EN ISO 9001



St Neots, U.K. – Cert. No. Q5907

Stonehouse, U.K. – Cert. No. FM 21106

EN 29001 (ISO 9001)



Lenno, Italy – Cert. No. 9/90A



Stonehouse, U.K. – Cert. No. 0255

Use of Instructions



Warning.

An instruction that draws attention to the risk of injury or death.



Note.

Clarification of an instruction or additional information.

Caution.

An instruction that draws attention to the risk of damage to the product, process or surroundings.



Information.

Further reference for more detailed information or technical details.

Although **Warning** hazards are related to personal injury, and **Caution** hazards are associated with equipment or property damage, it must be understood that operation of damaged equipment could, under certain operational conditions, result in degraded process system performance leading to personal injury or death. Therefore, comply fully with all **Warning** and **Caution** notices.

Information in this manual is intended only to assist our customers in the efficient operation of our equipment. Use of this manual for any other purpose is specifically prohibited and its contents are not to be reproduced in full or part without prior approval of Technical Communications Department, ABB Instrumentation.

Licensing, Trademarks and Copyrights

MODCELL™ and PC-30™ are trademarks of Asea Brown Boveri, Inc.

Modbus™ is a trademark of Modicon, Inc.

IBM™ and IBM PC AT™ are trademarks of International Business Machines Corp.

Health and Safety

To ensure that our products are safe and without risk to health, the following points must be noted:

1. The relevant sections of these instructions must be read carefully before proceeding.
2. Warning labels on containers and packages must be observed.
3. Installation, operation, maintenance and servicing must only be carried out by suitably trained personnel and in accordance with the information given.
4. Normal safety precautions must be taken to avoid the possibility of an accident occurring when operating in conditions of high pressure and/or temperature.
5. Chemicals must be stored away from heat, protected from temperature extremes and powders kept dry. Normal safe handling procedures must be used.
6. When disposing of chemicals ensure that no two chemicals are mixed.

Safety advice concerning the use of the equipment described in this manual or any relevant hazard data sheets (where applicable) may be obtained from the Company address on the back cover, together with servicing and spares information.

CONTENTS

Section	Page	Section	Page
1 INTRODUCTION	2	5 MODBUS FUNCTIONS	12
2 ELECTRICAL INSTALLATION	2	5.1 Read Coil Status –	
2.1 Selection of Serial		Function Code 01	12
Communication Adaptors for		5.1.1 Read Coil Status Query .	12
Personal Computers	2	5.1.2 Read Coil Status	
2.2 Recommended		Response	12
OPTO22 Boards	2	5.2 Read Holding Register –	
2.3 3-wire or 5-wire Operation	2	Function Code 03	13
2.4 Pull-up and Pull-down		5.2.1 Read Holding	
Resistors	3	Register Query	13
2.5 Termination Resistors	5	5.2.2 Read Holding	
2.6 RS485/422 Standard	5	Register Response	13
2.7 Serial Connections	7	5.3 Force Single Coil –	
3 PROGRAMMING	8	Function Code 05	14
3.1 Serial Data Communication		5.3.1 Force Single Coil	
Page	9	Query	14
4 MODBUS PROTOCOL	10	5.3.2 Force Single	
4.1 Introduction to Modbus		Coil Response	14
Protocol	10	5.4 Preset Single Register –	
4.1.1 Non-volatile memory		Function Code 06	15
Limitations	10	5.4.1 Preset Single Register	
4.2 Modbus Function Codes	11	Query	15
		5.4.2 Preset Single Register	
		Response	15
		5.5 Loopback Test –	
		Function Code 08	16
		5.5.1 Loopback Test	
		Query	16
		5.5.2 Loopback Test	
		Response	16
		5.6 Write Multiple Registers –	
		Function Code 16	17
		5.6.1 Write Multiple Register	
		Query	17
		5.6.2 Write Multiple Registers	
		Response	17
		6 EXCEPTION RESPONSES	18
		6.1 Examples	18
		7 MODBUS REGISTERS	19
		7.1 Coils	19
		7.2 Holding Registers	21
		7.3 Alarm Settings	22
		7.4 Ramp/Soak Settings	23
		7.5 Totalizer Settings	24

1 INTRODUCTION



Information.

- The COMMANDER 200 Series is extended by the addition of a serial data communication option designed for use with SCADA systems.
- RS422/485 Communication standard.
- Modbus RTU protocol – for master (host computer) to slave (COMMANDER 200) system.
- Isolated (500V) from rest of instrument.
- 3-wire and 5-wire communication supported.
- Baud rate – from 1200 to 9600.

2 ELECTRICAL INSTALLATION

2.1 Selection of Serial Communication Adaptors for Personal Computers



Information.

- An RS422/485 communication board is required in the host PC.
- Observe the limitations outlined in the Installation Guide – the maximum serial data transmission line length for both RS422 and RS485 systems is 1200m.

An RS422/485 communications adaptor is required for serial links. It is strongly recommended that the card used has galvanic isolation to protect the computer from lightning damage and increase immunity from noise pick-up.

2.2 Recommended OPTO22 Boards

The following OPTO22 boards are recommended for use with the COMMANDER 200 Series of instruments:

Part No.	Computer Type
AC24 AT	AT Bus IBM PC compatible
AC34	Microchannel IBM PC

2.3 3-wire or 5-wire Operation – Figs. 2.1 and 2.2

3-wire or 5-wire operation is selected using a plug-in link (PL5) on the serial board – see Fig. 2.1 for 3-wire operation or Fig. 2.2 for 5-wire operation.

2.4 Pull-up and Pull-down Resistors – Figs. 2.1 and 2.2

To prevent false triggering of the slave (COMMANDER 200) by the presence of noise when the master (host computer) is inactive, 1.8k pull-up and pull-down resistors must be fitted to the RS422/485 adaptor card – see Figs. 2.1 and 2.2.

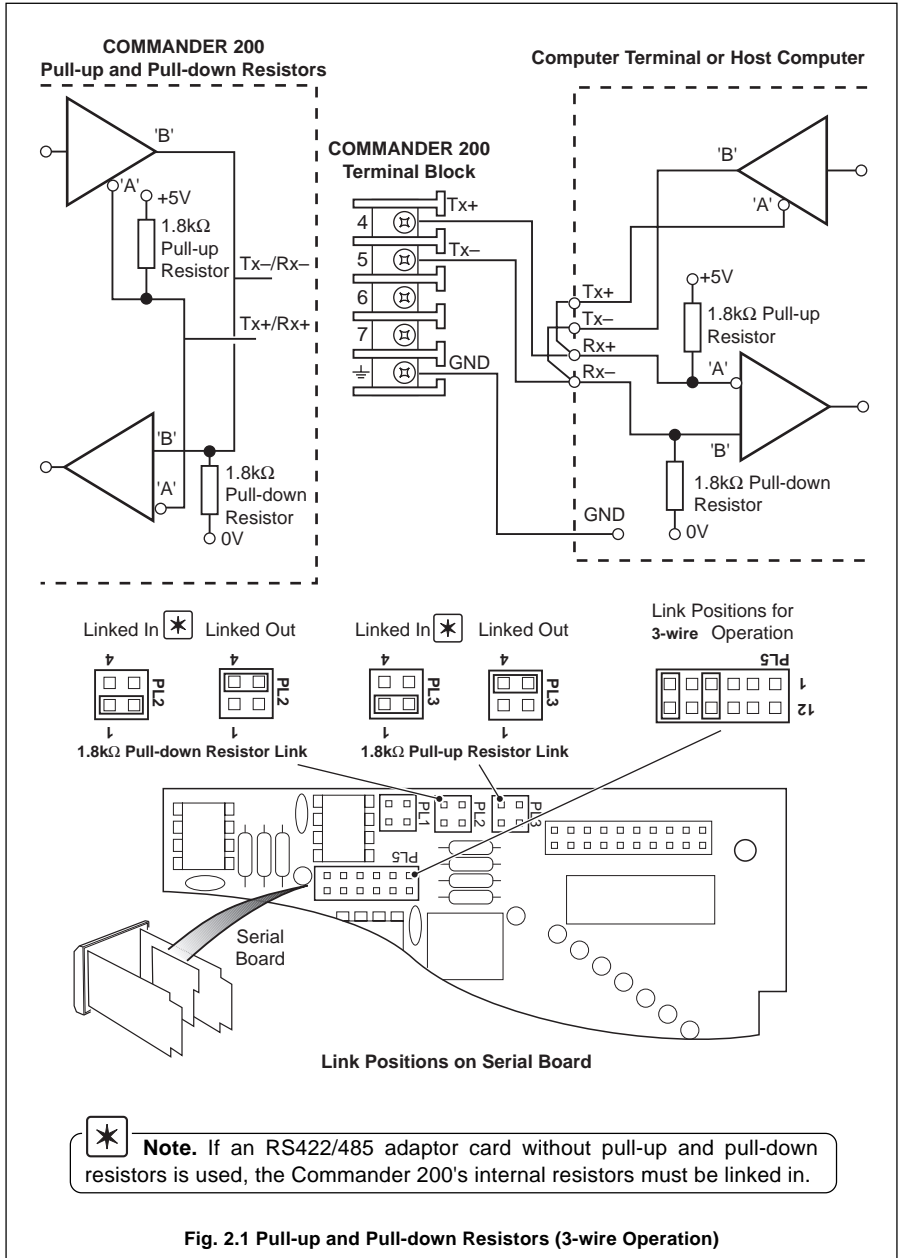

Fig. 2.1 Pull-up and Pull-down Resistors (3-wire Operation)

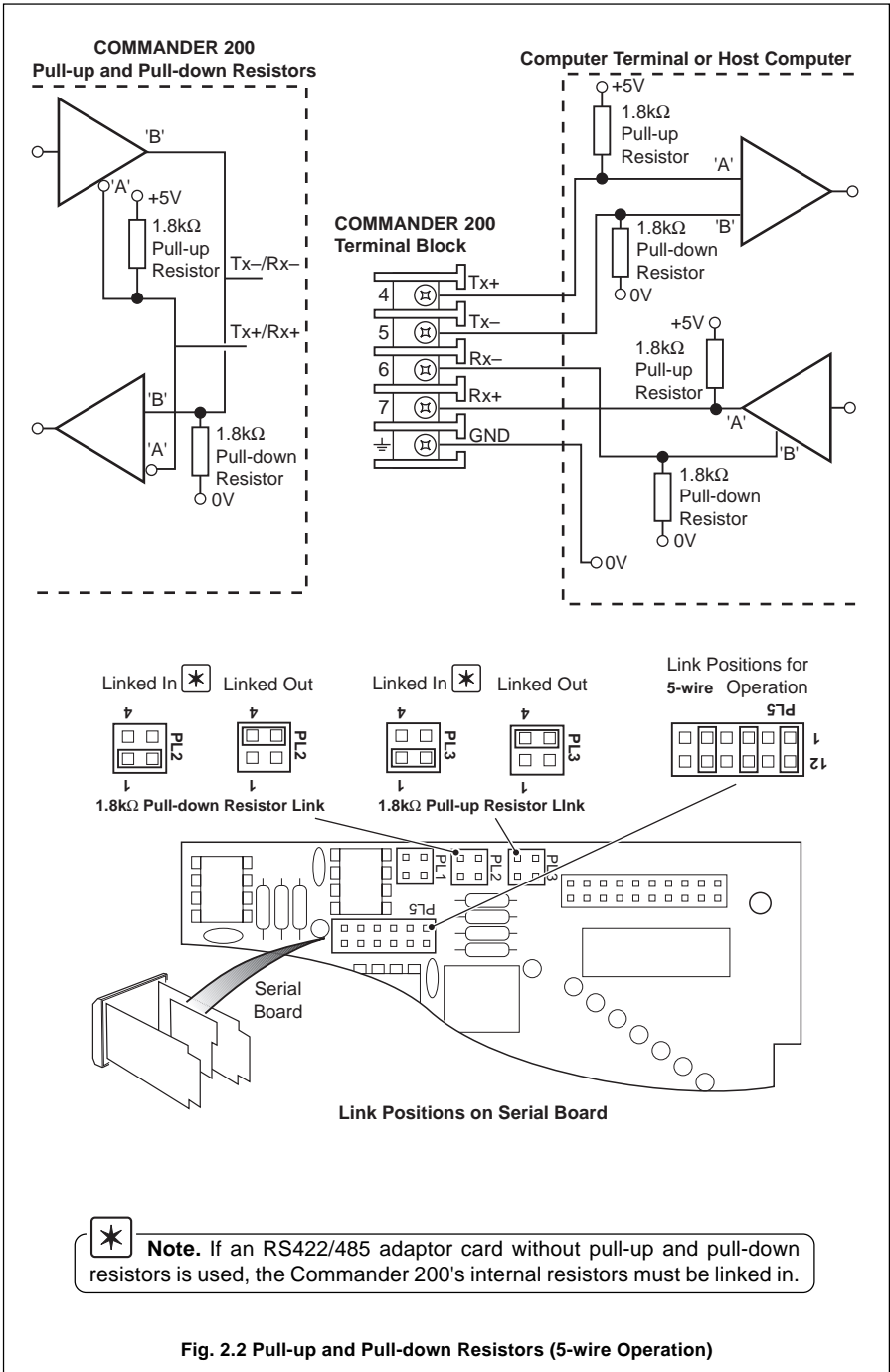

Fig. 2.2 Pull-up and Pull-down Resistors (5-wire Operation)

2.5 Termination Resistors – Figs. 2.3 and 2.4

For long transmission lines, termination resistors are required on the last slave in the chain and the host computer/computer terminal – see Figs. 2.3 and 2.4. Under normal operating conditions the resistors are required at the receive inputs only. For **3-wire** operation the slave termination resistor is selected using a plug-in link (PL1) on the serial board – see Fig. 2.3. For **5-wire** operation the slave termination resistor is selected using a plug-in link (PL5) on the serial board – see Fig. 2.4.

2.6 RS485/422 Standard

The RS485 standard quotes connection of thirty two slaves maximum, to any single driver (computer terminal or host computer); the RS422 standard quotes connection of up to ten slaves. However, these numbers can be increased if the driver's serial port permits.

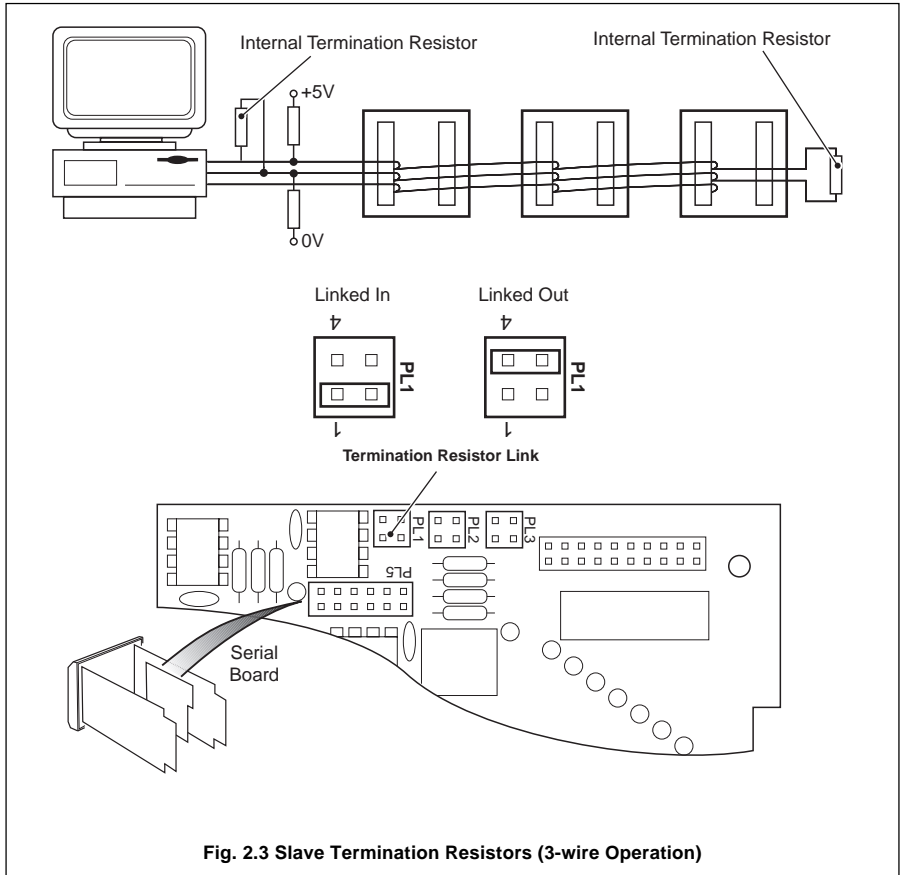

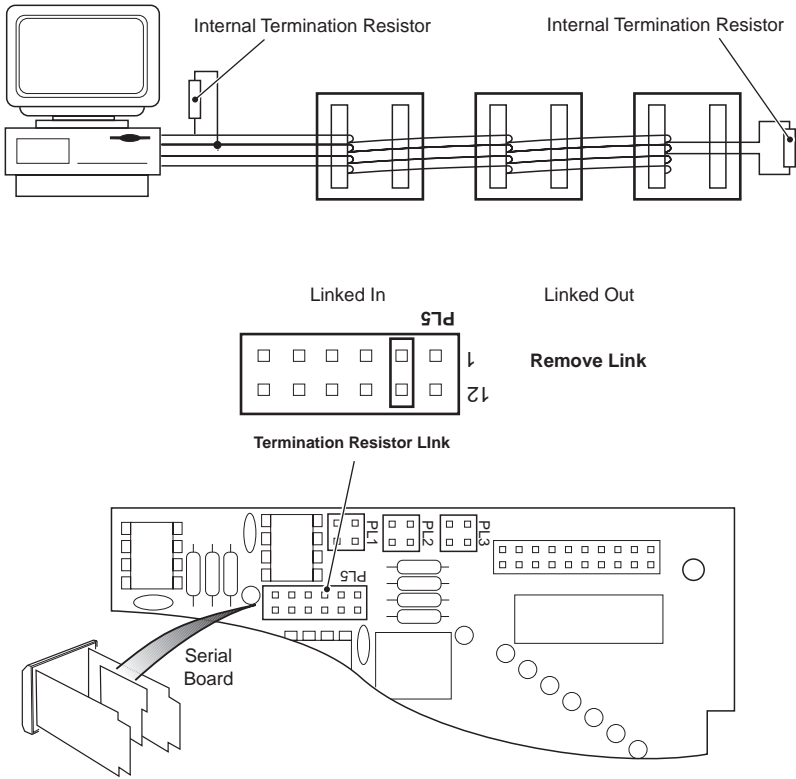

Fig. 2.4 Slave Termination Resistors (5-wire Operation)

2.7 Serial Connections – Fig. 2.5



Information.

- Up to **10 slaves** can be connected to a single **RS422** adaptor card on a PC.
- Up to **32 slaves** can be connected to a single **RS485** adaptor card on a PC.
- The maximum serial data transmission line length for both **RS422** and **RS485** systems is 1200m.

All connections, apart from those for serial data communication, are made as shown in Section 1 of the *Operating Instructions*.

Make serial data connections as shown in Fig. 2.5. The type of cable used is dependent on the cable length:

- Up to 6m** – standard screened or twisted pair cable
- Up to 300m** – twin twisted pair with overall foil screen and an integral drain wire, e.g. Belden 9502 or equivalent
- Up to 1200m** – twin twisted pair with separate foil screens and integral drain wires for each pair, e.g. Belden 9729 or equivalent

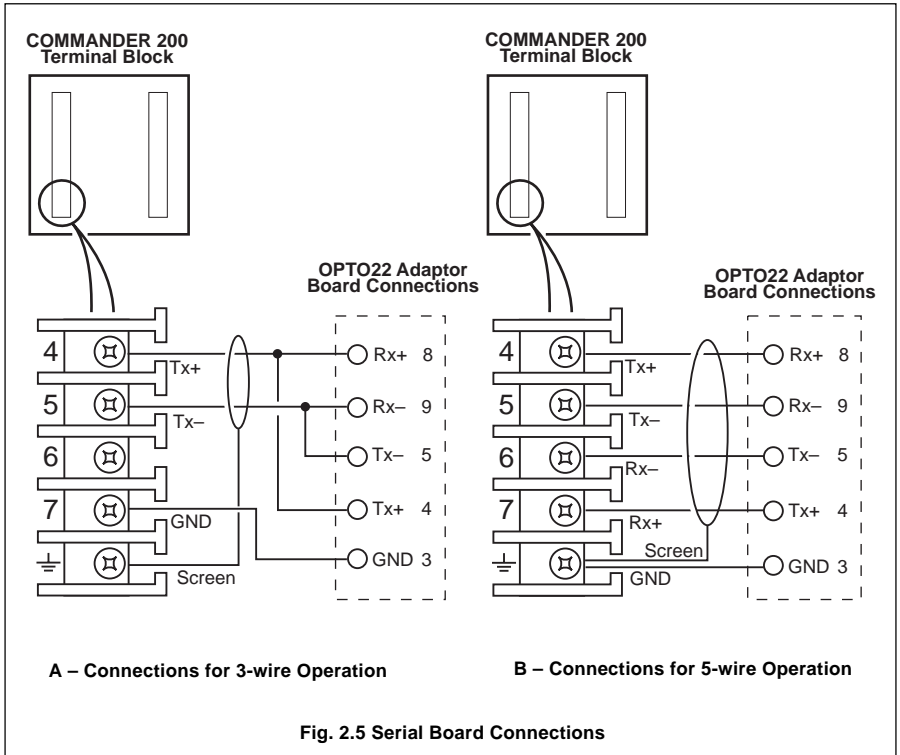

Fig. 2.5 Serial Board Connections

3.1 Serial Data Communication Page



Information.

- Programmable baud rate (1200 to 9600 baud).
- Odd or even parity.

The general programming procedure is as detailed in the *Operating Instructions*. In this Section, parameters in the lower display denoted ■ are Company Standard Settings. The instrument is dispatched programmed with these settings.

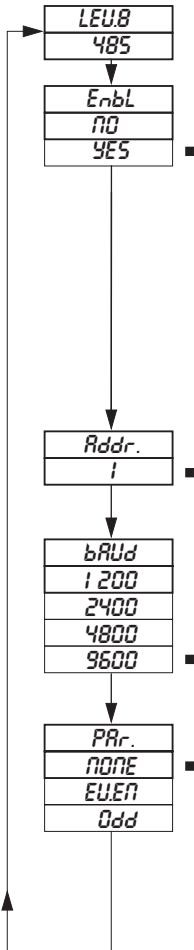

Page Header – **Level 8, RS485.**

Enable RS485

Select *YES* to enable RS485.

The enable/disable entry provides the means to disable the serial communications port and lock out the host computer. When enabled, the communications task is started and operations can be implemented from the front panel or from the host computer.

The instrument responds to the most recent command (either from the front panel controls or from the host computer via the interface). When the port is disabled, operations can only be implemented from the front panel.

Controller Address

Assign the controller an identification number between 1 and 99.

Transmission Rate

Select the retransmission rate required (1200 slowest, 9600 fastest).

Parity

Select the appropriate parity to match the computer terminal or host computer.

- none* – no parity.
- EVEN* – even parity.
- ODD* – odd parity.

Return to **Level 8, RS485** frame.

4 MODBUS PROTOCOL



Information.

- The COMMANDER 200 operates as a Modbus, Remote Terminal Unit (RTU) slave.
- Parity checking – used to detect transmission errors in individual characters.
- Cyclic redundancy checking – used to detect errors in the master messages and slave responses.
- Non-volatile memory save command.

4.1 Introduction to Modbus Protocol

Modbus communication is based on a master and a slave arrangement. The master sends a message to one slave at a time and waits for a reply.

The slave cannot accept a new message until the existing message is processed and a reply sent to the master (maximum response time 250 milliseconds). The slave monitors the elapsed time between receipt of characters. If the elapsed time without a new character is $3\frac{1}{2}$ character times, the slave assumes the next character received is the start of a new message.

To allow the master to differentiate between more than one slave in a system, each slave is given a unique identity address (between 1 and 99).

A broadcast address (address zero) can be used to access all slave devices with one command. This is limited to write messages only and there is no slave acknowledgment.



Note. Modbus RTU requires 1 start bit, 8 data bits, 1 parity bit (optional) and 1 or 2 stop bits.

4.1.1 Non-volatile Memory Limitations



Caution. If the number of write cycles to any particular non-volatile memory register exceeds 10^4 cycles, the data stored may not be retained.

Any changes made to a parameter via the serial link, e.g. Control Set Point value, are stored in a non-volatile memory register assigned to that parameter.

The number of write cycles to a particular register can be reduced by disabling non-volatile memory access when making changes to parameters which do not need to be retained following a power-down. This is done using the **Non-volatile Save State (NV)** – see Section 8.6.1, General Parameters.

When the **Non-volatile Save State** is set to 'Enable', any parameter changes made via the serial link are written to non-volatile memory and are retained on power-down. If the **Non-volatile Save State** is set to 'Disable', parameter changes made via the serial link are not retained on power down.

The **Non-volatile Save State** must be adjusted only when necessary and must be reset to the required state each time the instrument is powered down, replaced with another instrument or the host computer is powered down.

4.2 Modbus Function Codes

The function code field instructs the addressed slaves which function to perform. Table 4.1 shows the function codes, their meaning, and the action they initiate.

Modbus Function Code	Modbus Message Name	MODCELL 2050 Definition
01	Read Coil Status	Read up to 16 consecutive discrete (boolean) points from a specific starting point. The COMMANDER 200 returns zeros for points which do not contain defined data and NAKs* any request for point numbers greater than 200.
03	Read Holding Register	Read up to 8 consecutive registers from a specific starting register. The COMMANDER 200 returns zeros for points which do not contain defined data and NAKs* any request for point numbers greater than 250.
05	Force Single Coil	Write one discrete (boolean) point. The COMMANDER 200 NAKs* this if the point is not currently writeable.
06	Preset Single Register	Write one register. The COMMANDER 200 naks if the register is not currently writeable. This function code also applies to any currently applicable limits t the value before storage in the database.
08	Loop Back Diagnostic Test	Echo the message, only 'Return of Query' is supported.
16	Preset Multiple Registers	Write up to 8 consecutive registers from a specified starting register. The COMMANDER 200 naks if any of the registers are not currently writeable, but still carries out all the writes which are still valid, applying any current applicable limits to the value before storage in the database. This function code is only available if 'write ot non-volatile memory' is disabled – see coil number 181.

*NAK = Negative Acknowledgment

Table 4.1 Modbus Function Codes

5 MODBUS FUNCTIONS

This section shows typical examples of Modbus function codes 01, 03, 05, 06, 08 and 16.

5.1 Read Coil Status – Function Code 01

5.1.1 Read Coil Status Query

This function allows the user to obtain the ON/OFF status of logic coils used to control discrete outputs from the addressed slave only. Broadcast mode is not supported with this function code. In addition to the slave address and function fields, the message requires that the information field contain the initial coil offset address to be read (starting address) and the number of locations to be interrogated must obtain status data.



Note. The coil offset address is the coil number minus one, e.g. to start at coil 11 the data start value must be set to 10 (0AH).

Example – a read coil status request to read 16 coils from slave (01) starting at coil 11 (Process Variable mA low) is shown below.

Address	Function	Coil Start Offset High	Coil Start Offset Low	Number of Coils High	Number of Coils Low	Error Check Field	(CRC-16)
01	01	00	0AH	00	10	1D	C4

5.1.2 Read Coil Status Response

The data is packed one bit for each coil (1 = ON, 0 = OFF). The response includes the slave address, function code, quantity of data characters, the data characters and error checking. The low order bit of the first character contains the first addressed coil and the remainder follow. For coil quantities that are not even multiples of eight, the last characters are filled in with zeros at high order end.

Example – the response to the read coil status query shows the following:

All input failure states and A to D converter failure states OFF (no errors)
Alarm 1 Relay ON

Address	Function	Byte Count	Data Coil Status 31 to 38	Data Coil Status 39 to 46	Error Check Field	(CRC-16)
01	01	02	00	01	BA	AC

5.2 Read Holding Register – Function Code 03

5.2.1 Read Holding Register Query

The Read holding registers allow the user to obtain the binary contents of holding registers in the addressed slave.



Note. The data start register must contain the offset address of the first register to be accessed, e.g. to start at register 121 the data start register must contain 120 (78H).

Broadcast mode is not allowed.

Example – a read holding register request to read 4 holding registers from slave (01) starting at holding address 121 (alarm 1 trip value) is shown below.

Address	Function	Byte Count	Data Coil Status 31 to 38	Data Coil Status 39 to 46	Error Check Field	(CRC-16)
01	01	02	00	01	BA	AC

5.2.2 Read Holding Register Response

The addressed slave responds with its address and function code, followed by the information field. The information field contains 1 byte describing the quantity of data bytes to be returned. The contents of each register requested (DATA) is two bytes, the first byte includes the high order bits and the second the low order bits.

Example – the response to the read holding register query shows the following:

```
Alarm 1 trip – 150
Alarm 2 trip – 50
Alarm 3 trip – 100
Alarm 4 trip – 400
```

Address	Function	Byte Count	Holding Register 121 High Low	Holding Register 122 High Low	Holding Register 123 High Low
01	03	08	00 96	00 32	00 64

Holding Register 124 High Low	Error Check Field	(CRC-16)
01 90	1A	39

5.3 Force Single Coil – Function Code 05

5.3.1 Force Single Coil Query

This message forces a single coil either ON or OFF. The data value 65,280 (FF00 HEX) sets the coil ON and the value zero turns it OFF. All other values are illegal and do not affect the coil.



Note. To write to a coil the coil offset address must be used, e.g. to write to coil 149, the coil address 148 (94H) is transmitted.

The use of slave address zero (broadcast mode) forces all attached slaves to modify the desired coil.

Example – a force single coil request to switch ON coil address 149 (auto/manual state, channel 1) in slave 01 is shown below.

Address	Function	Coil Offset High	Coil Offset Low	Data Value High	Data Value Low	Error Check Field	(CRC-16)
01	05	00	94	FF	00	CD	D6

5.3.2 Force Single Coil Response

The response is confirmation of the query after the coil state has been altered.

Example:

Address	Function	Coil Offset High	Coil Offset Low	Data Value High	Data Value Low	Error Check Field	(CRC-16)
01	05	00	94	FF	00	CD	D6

5.4 Preset Single Register – Function Code 06

5.4.1 Preset Single Register Query

The preset single register allows the user to modify the contents of a holding register.



Note. Function codes 5, 6 and 16 are the only messages that are recognized as valid for broadcast.

Example – a preset single register request to write the value 500 to holding register address 121 (alarm 1 trip value) in slave 01 is shown below.



Note. To write to a register, the register's offset address must be used, e.g. to write to register 121, the offset address 120 (78H) is transmitted.

Address	Function	Register Offset High	Register Offset Low	Data Value High	Data Value Low	Error Check Field	(CRC-16)
01	06	00	78	01	F4	09	C4

5.4.2 Preset Single Register Response

The normal response to a preset single register request is to retransmit the query message after the register has been altered.

Example:

Address	Function	Register Offset High	Register Offset Low	Data Value High	Data Value Low	Error Check Field	(CRC-16)
01	06	00	78	01	F4	09	C4

5.5 Loopback Test – Function Code 08**5.5.1 Loopback Test Query**

The purpose of the loopback test is to test the Modbus system, it does not affect the content of the controller. Variations in the response may indicate faults in the Modbus system. The information field contains 2 bytes for the designation of the diagnostic code followed by 2 bytes to designate the action to be taken.

Example:

Address	Function	Data Diagnostic Code High	Data Diagnostic Code Low	Data *	Data *	Error Check Field	(CRC-16)
01	08	00	00	A5	37	DA	8D

*These are considered to be the information fields for diagnostic mode.

5.5.2 Loopback Test Response

The response always echoes the query, only diagnostic code 0 (bytes 3 and 4) can be used.

Example:

Address	Function	Data Diagnostic Code High	Data Diagnostic Code Low	Data	Data	Error Check Field	(CRC-16)
01	08	00	00	A5	37	DA	8D

5.6 Write Multiple Registers – Function Code 16

5.6.1 Write Multiple Registers Query

Holding registers existing within the controller can have their contents changed by this message (a maximum of 8 registers). When used with slave address zero (broadcast mode) all slave controllers load the selected registers with the contents specified.

Example – a write multiple register request to write the value 10 to the register address 121 (Alarm 1 trip value) and the value 100 to the register address 122 (Alarm 2 trip value) in slave 01 is shown below.

Address	Function	Register Start Offset High	Register Start Offset Low	Number of Registers	Byte Count
01	10	00	78	00 02	04

Holding Register 121 High	Holding Register 121 Low	Holding Register 122 High	Holding Register 122 Low	Error Check Field	(CRC-16)
00	0A	00	64	D4	C4

5.6.2 Write Multiple Registers Response

The response confirms slave identification, function code, starting register address and quantity only.

Example:

Address	Function	Register Start Offset High	Register Start Offset Low	Number of Registers		Error Check Field	(CRC-16)
01	10	00	78	00	02	00 10	90

6 EXCEPTION RESPONSES

The exception response codes sent by the slave are shown in Table 6.1. When a slave detects one of these errors, it sends a response message to the master consisting of the slave address, function code, error code and error check fields.

Exception Response Code	Exception Response Name	Exception Response Definition
01	Illegal Function	The message function received is not an allowable action for the COMMANDER 200.
02	Illegal Data Address	The address reference in the data field is not an allowable address for the COMMANDER 200.
03	Illegal Data Value	The value referenced in the data field is not allowable in the addressed slave location.
07	NAK*	The function just requested cannot be performed.
08	Memory Parity Error	Parity check indicates an error in one or more of the characters received.

*NAK = Negative Acknowledgment

Table 6.1 Exception Response Codes

6.1 Examples

A read register request to read holding register address 251 of slave 01 (undefined address for slave, beyond address limit) is shown below.

Address	Function	Register Start Offset High	Register Start Offset Low	Number of Registers High	Number of Registers Low	Error Check Field	(CRC-16)
01	03	00	FA	00	06	E5	F9

The response is an exception response signaling 'illegal data address'. To indicate that the response is a notification of an error, the most significant bit of the function code is set to 1.

Slave Address	Function	Exception Code	Error Check Field	(CRC-16)
01	83	02	C0	F1

7 MODBUS REGISTERS

7.1 Coils

Coil Number	Read/Write	Description	Response/Entry
Input Failure States			
011	R	Process Variable mA Low	} 0 = Active 1 = Failed
012	R	Process Variable mA High	
013	R	Process Variable RTD Low	
014	R	Process Variable RTD High	
015	R	Process Variable Thermocouple High	
016	R	Process Variable V Low	
017	R	Process Variable V High	
018	R	Remote Set Point High	
019	R	Remote Set Point Low	
020	R	Remote Set Point Fail State	
A to D converter Failure States			
021	R	Process Variable Fail State	} 0 = Active 1 = Failed
022	R	Process Variable SCI Communications Error	
023	R	Remote Set Point Fail State	
024	R	Remote Set Point SCI Communications Error	
025	R	Process Variable Global Fail State	
Alarm Status			
031	R	Alarm 1	} 0 = Inactive 1 = Active
032	R	Alarm 2	
033	R	Alarm 3	
034	R	Alarm 4	
035	R	Control Relay	
036	R	Alarm Relay B	
037	R	Alarm Relay C	
Input State			
051	R	Logic Input 1	0 = Active, 1 = Inactive
Multiple Read Group			
061	R	Alarm 1	} 0 = Inactive 1 = Active
062	R	Alarm 2	
063	R	Alarm 3	
064	R	Alarm 4	
065	R	Logic Input 1	0 = Active, 1 = Inactive
066	R	Control Action	0 = Direct, 1 = Reverse
067	R	Auto/Manual	0 = Auto, 1 = Manual
068	R	Control Relay	
069	R	Alarm Relay B	} 0 = Inactive 1 = Active
070	R	Alarm Relay C	

...7 MODBUS REGISTERS

...7.1 Coils

Coil Number	Read/Write	Description	Response/Entry
		Control States	
148	R/W	Control Action	0 = Direct, 1 = Reverse
149	R/W	Auto/Manual	0 = Auto, 1 = Manual
150	R/W	Integral Response	0 = Off, 1 = On
151	R/W	Manual Response	0 = Off, 1 = On
		Totalizer control states	
171	R/W	Totalizer Count Direction	0 = Down, 1 = Up
172	R/W	Totalizer Enable State	0 = Disable, 1 = Enable
173	R/W	Totalizer On/Off State	0 = Off, 1 = On
174	R/W	Totalizer Wrap Enable State	0 = Disable, 1 = Enable
181	R/W	Enable Writes to Non-Vol Memory	0 = Disable, 1 = Enable

7.2 Holding Registers

Register No.	Read/Write	Description	Response/Entry
Process Variable Inputs			
011	R	Process Variable	-9999 to +9999
012	R	Remote Set Point	-9999 to +9999
019	R	Process Variable Decimal Point Position	0.3 Decimal Places
031	R	Full Scale Value For Process Variable	
032	R	Zero Value For Process Variable	In Engineering Units Range -9999 to +9999
041	R	Display Span For Process Variable	
042	R	Display Zero For Process Variable	
043	R	Remote Set Point High	
044	R	Remote Set Point Low	
Controller Settings			
051	R	Process Variable Input	-9999 to +9999
052	R/W	Control Set Point	-9999 to +9999
053	R/W	Control Output	0 to 1000
057	R/W	Cycle Time	10 to 3000
058	R/W	Proportional Band	1 to 9999
059	R/W	Integral Reset Rate	1 to 1200
060	R/W	Manual Reset Value	0 to 1000
061	R/W	Derivative Action Time	0 to 9999
071	R	Remote Set Point Input Value	-9999 to +9999
074	R/W	Ratio for Remote Set Point	1 to +9999
075	R/W	Bias for Remote Set Point	-999 to +9999
Set Points			
101	R/W	Local Set Point	-9999 to +9999
102	R/W	Dual Set Point	
103	R	Remote Set Point (without Ratio/Bias)	-9999 to +9999
104	R	Remote Set Point (with Ratio/Bias)	
105	R	Remote Set Point Failure State	
106	R/W	Set Point Selection	0 = Local, 1 = 2nd SP

7.3 Alarm Settings

Register No.	Read/Write	Description	Response/Entry
121	R/W	Alarms Alarm 1 Trip Value	} In Engineering Units Range -9999 to +9999
122	R/W	Alarm 2 Trip Value	
123	R/W	Alarm 3 Trip Value	
124	R/W	Alarm 4 Trip Value	
141	R	Alarm 1 Type	} 0 = None 1 = High Process 2 = Low Process 3 = High Deviation 4 = Low Deviation 5 = High Output 6 = Low Output
142	R	Alarm 2 Type	
143	R	Alarm 3 Type	
144	R	Alarm 4 Type	

7.4 Ramp/Soak Settings

Register No.	Read/Write	Description	Response/Entry
171	W	Ramp Soak Settings Ramp Soak Run State	1 = Run Profile
172	W	Ramp Soak Hold Command	1 = Hold Profile
173	W	Ramp Soak Skip	1 = Skip
175	W	Ramp Soak Reset State	1 = Reset Profile
176	R	Profile Status	<ul style="list-style-type: none"> 0 = Off 1 = Ramp 2 = Soak 3 = Step 4 = Countdown 5 = Operator Hold 6 = Power Down Hold 7 = Manual Mode 8 = Hold Back Mode 9 = End
178	R	Remaining Segment Time	0 to 9999
179	R/W	Selected Program	Program to Run 1 to 5

7.5 Totalizer Settings

Register No.	Read/Write	Description	Response/Entry
191	R	Totalizer Totalizer Predetermined High Word	} The Limit For High Word : Low Word linked together is 0 to 99,999,999 1 = Reset 0 = Stop, 1 = Go
192	R	Totalizer Predetermined Low Word	
193	R	Totalizer Preset High Word	
194	R	Totalizer Preset Low Word	
195	R	Totalizer Value High Word	
196	R	Totalizer Value Low Word	
197	W	Totalizer Reset	
198	R/W	Totalizer Stop/Go	

PRODUCTS & CUSTOMER SUPPORT

A Comprehensive Product Range

Analytical Instrumentation

- **Transmitters**
On-line pH, conductivity, and dissolved oxygen transmitters and associated sensing systems.
- **Sensors**
pH, redox, selective ion, conductivity and dissolved oxygen.
- **Laboratory Instrumentation**
pH and dissolved oxygen meters and associated sensors.
- **Water Analyzers**
For water quality monitoring in environmental, power generation and general industrial applications including: pH, conductivity, ammonia, nitrate, phosphate, silica, sodium, chloride, fluoride, dissolved oxygen and hydrazine.
- **Gas Analyzers**
Zirconia, paramagnetic, infrared, thermal conductivity.

Controllers & Recorders

- **Controllers**
Digital display, electronic, pneumatic. Discrete single-loop and multi-loop controllers which can be linked to a common display station, process computer or personal computer.
- **Recorders**
Circular and strip-chart types (single and multi-point) for temperature, pressure, flow and many other process measurements.

Electronic Transmitters

- **Smart & Analog Transmitters**
For draft, differential, gauge and absolute pressure measurement. Also, liquid level and temperature.
- **I to P Converters and Field Indicators**

Flow Metering

- **Magnetic Flowmeters**
Electromagnetic, insertion type probes and watermeters.
- **Turbine Flowmeters**
- **Wedge Flow Elements**
- **Mass Flow Meters**
Transmitters, sensors, controllers and batch/display units.

Level Control

- **Submersible, Capacitance & Conductivity.**

Pneumatic Instrumentation

- **Transmitters**
- **Indicating Controllers**
- **Recording Controllers**

Customer Support

ABB Instrumentation provides a comprehensive after sales service via a Worldwide Service Organization. Contact one of the following offices for details on your nearest Service and Repair Centre.

United Kingdom

ABB Instrumentation Limited
Tel: +44 (0)1480 475321
Fax: +44 (0)1480 470787

United States of America

ABB Instrumentation Inc.
Tel: +1 716 292 6050
Fax: +1 716 273 6207

Italy

ABB Kent-Taylor SpA
Tel: +39 (0) 344 58111
Fax: +39 (0) 344 58278

Client Warranty

Prior to installation, the equipment referred to in this manual must be stored in a clean, dry environment, in accordance with the Company's published specification. Periodic checks must be made on the equipment's condition.

In the event of a failure under warranty, the following documentation must be provided as substantiation:

1. A listing evidencing process operation and alarm logs at time of failure.
2. Copies of operating and maintenance records relating to the alleged faulty unit.



The Company's policy is one of continuous product improvement and the right is reserved to modify the information contained herein without notice.

© ABB 1999

Printed in UK (1.99)

ABB Instrumentation Ltd.

St. Neots
Cams.
England, PE19 3EU
Tel: +44 (0) 1480 475321
Fax: +44 (0) 1480 217948

ABB Instrumentation Inc.

PO Box 20550, Rochester
New York 14602-0550
USA
Tel: +1 716 292 6050
Fax: +1 716 273 6207

ABB Kent-Taylor SpA

22016 Lenno
Como
Italy
Tel: +39 (0) 344 58111
Fax: +39 (0) 344 58278